

Recomendações de uso do móvel

•Não deixe o produto exposto a raios solares, excesso de umidade ou água.

•Não utilize qualquer produto derivado de petróleo, como querosene, thinner, gasolina, amoníacos, ácido ou equivalentes para a limpeza do móvel.

•Para limpeza, utilize pano macio levemente umedecido ou produtos indicados para limpeza de móveis, como lustra móveis ou equivalentes.

- Peso Maximo Recomendados

8 kg em cada Gaveta

8 kg sobre o Tampo

-Para movimentar o Móvel, deve-se retirar os objetos de dentro aliviando o peso evitando danos.

-Pisos Desniveados e irregulares, comprometem a estabilidade e esquadro do Móvel, podendo causar o empenamento nas peças, dificuldade de regular e alinhar as gavetas.

-Acompanha junto aos acessórios, um **KIT ANTI TOMBAMENTO**, que deve ser instalado como prevenção de acidentes.

-Nunca abrir todas as gavetas ao mesmo tempo e nem utilizá-las ou qualquer parte do produto como apoio ou degraus para escalar o móvel ou parede.

-Garantia de 90 dias legais, conforme artigo 26 da lei 8.078.-1990.

-O desgaste natural do móvel, problemas decorrentes da montagem inadequada, não são cobertos pela garantia

IMPORTANTE! Ferramentas necessárias ou recomendadas para a montagem não inclusas e não fornecidas com o produto.

Recomenda-se o uso de ferramentas manuais.

No caso de uso de parafusadeira, iniciar o com regulagem de torquedo equipamento na escala mínima, evitando espanar as roscas e danificar as peças

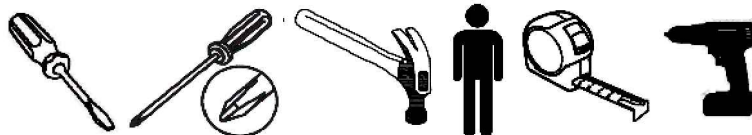

IMPORTANTE! Verifique os Parafusos na escala antes de aplica-los nas peças.

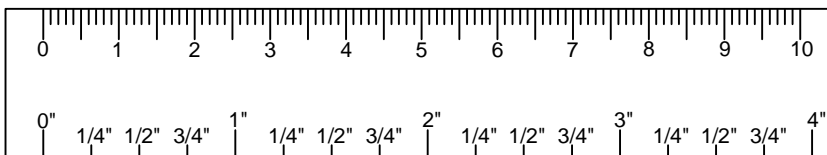





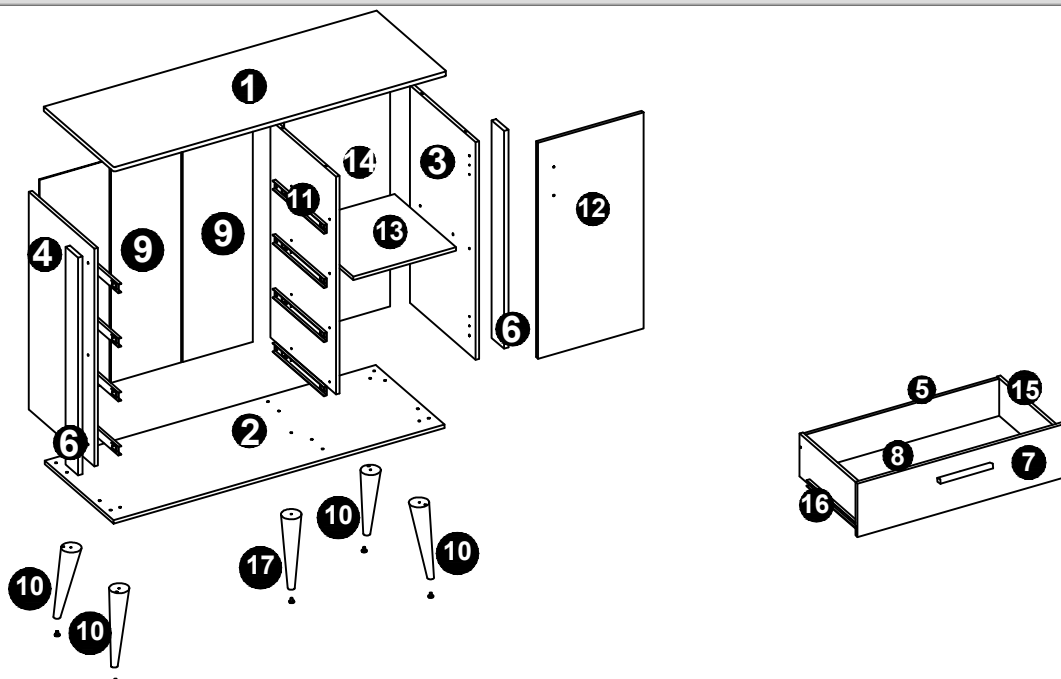







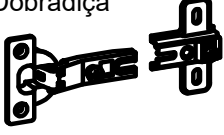
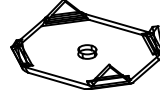

CÔMODA SAPATEIRA ÍSIS

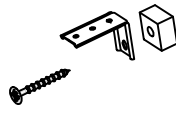
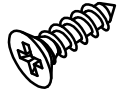
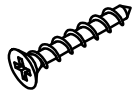
IDENTIFICAÇÃO DOS COMPONENTES

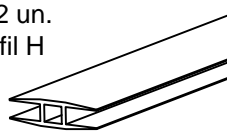

Nº ID	DESCRIÇÃO	QUANTIDADE	DIMENSÕES(mm)	MATERIAL
1	Tampo	1	1125x410x15	MDF
2	Base	1	1120x403x12	MDF
3	Lateral Direita	1	736x385x12	MDF
4	Lateral Esquerda	1	736x385x12	MDF
5	Traseiro da Gaveta	4	656x125x12	MDF
6	Moldura Lateral	2	736x73x15	MDF
7	Frente da Gaveta	4	716x181x12	MDF
8	Fundo da Gaveta	4	667x365x2,8	MDF
9	Traseiro do Gaveteiro	3	756x237x2,8	MDF
10	Pé Retrô Inclinado	4	200xØ60	MADEIRA
11	Divisória	1	736x385x12	MDF
12	Porta	1	730x357x12	MDF
13	Prateleira Móvel	1	360x347x2,8	MDF
14	Traseiro Sapateira	1	756x362x2,8	MDF
15	Lateral Direita da Gaveta	4	360x145x12	MDF
16	Lateral Esquerda da Gaveta	4	360x145x12	MDF
17	Pé Retrô Central	1	185x60x20	MADEIRA

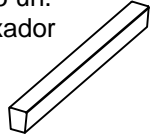
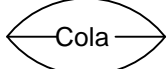
IDENTIFICAÇÃO DOS ACESSÓRIOS

A 1 un. Bucha Niveladora 	B 2 un. Calço da Dobradiça 	C 14 un. Cantoneira c/ Tampo 	D 48 un. Cavilha 6x30 	E 40 Pares Corrediça 
F 2 un. Dobradiça 	G 6 un. Junção Traseira 	H 1 un. Nivelador Oitavado 	I 1 un. Kit Anti Tombamento 	J 96 un. Parafuso 3,5x12 
K 16 un. Parafuso 3,5x22 	L 8 un. Parafuso 3,5x40 	M 8 un. Parafuso 5x40 	N 5 un. Parafuso 6x60 	O 2 un. Perfil H 
P 80 un. Prego 	Q 5 un. Puxador 	R 2 un. Sachet de Cola 	S 4 un. Sapata c/ Pino 	T 4 un. Suporte Prateleira 

CÔMODA SAPATEIRA ÍSIS

PASSO 1: Montagem dos Pés

Usar cola no topo dos Pés e Cavilhas

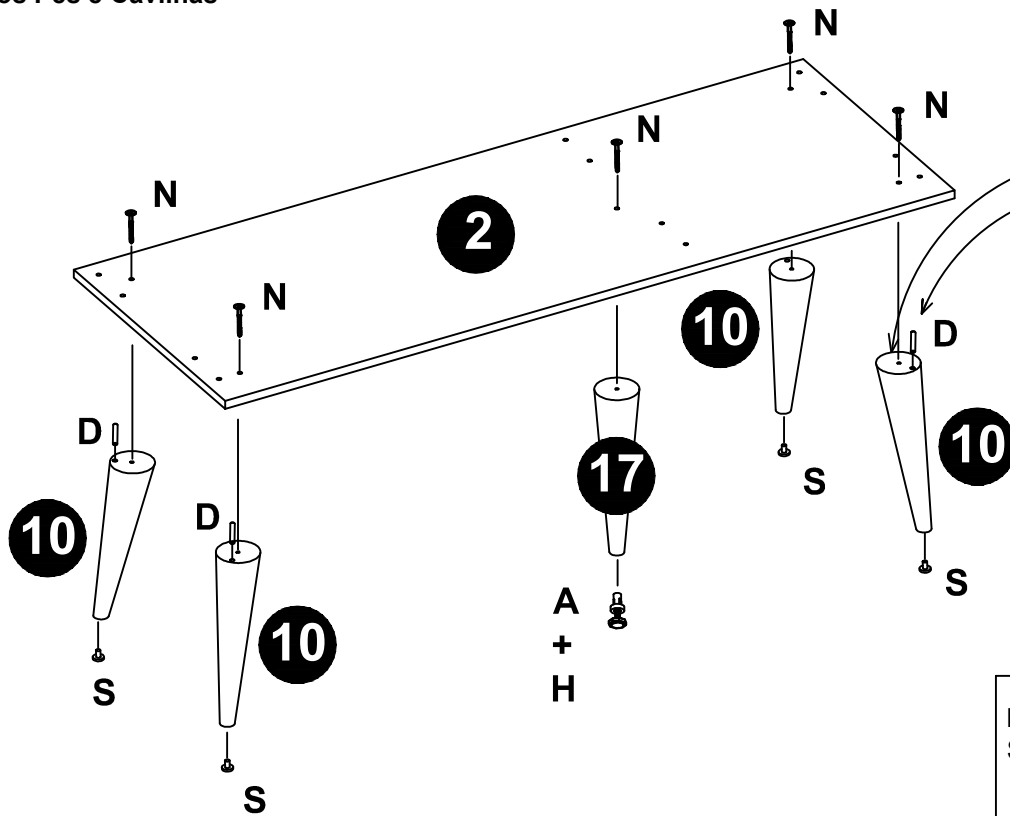

A 1 un.
Bucha Niveladora



R 1 un.
Sache de Cola

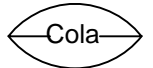

S 4 un.
Sapata

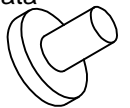

N 4 un.
Parafuso 6X60



R 1 un.
Sache de Cola

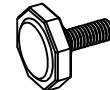

D 4 un.
Cavilha 6x30



PASSO 2: Montagem das Corrediças nas Laterais

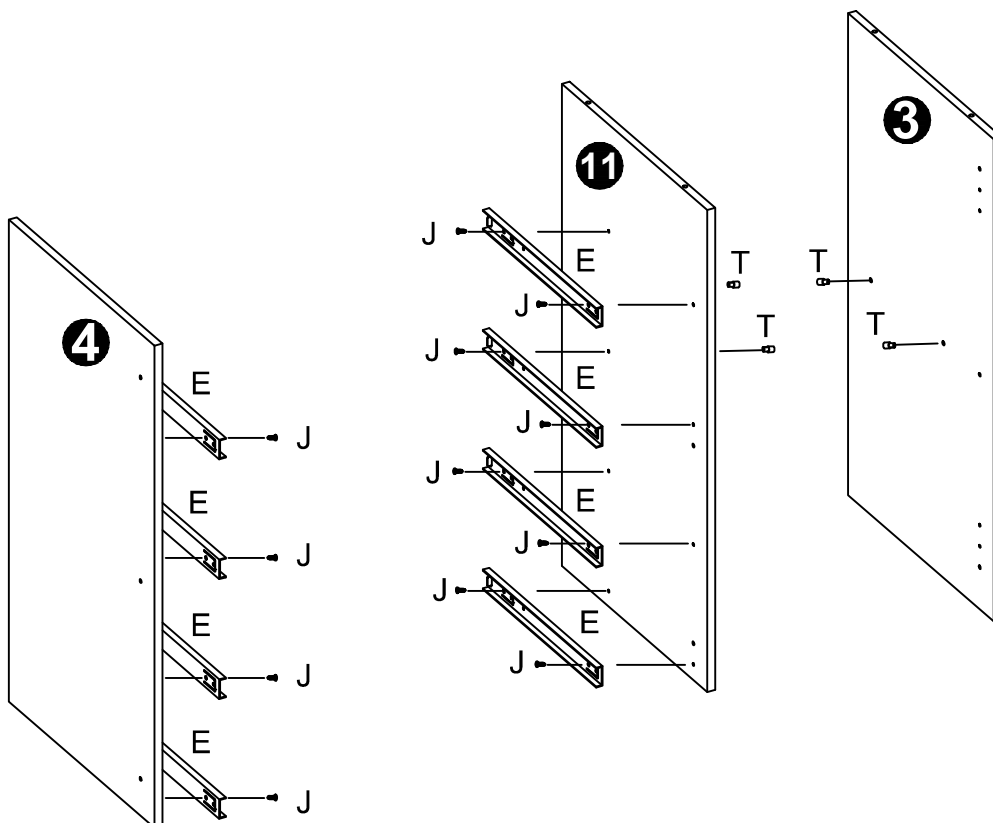

E 4 Pares
Corrediça



J 16 un.
Parafuso 3,5x12

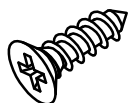

T 4 un.
Suporte Prateleira



CÔMODA SAPATEIRA ÍSIS

PASSO 3: MONTAGEM DAS LATERAIS E DIVISÓRIA NA BASE

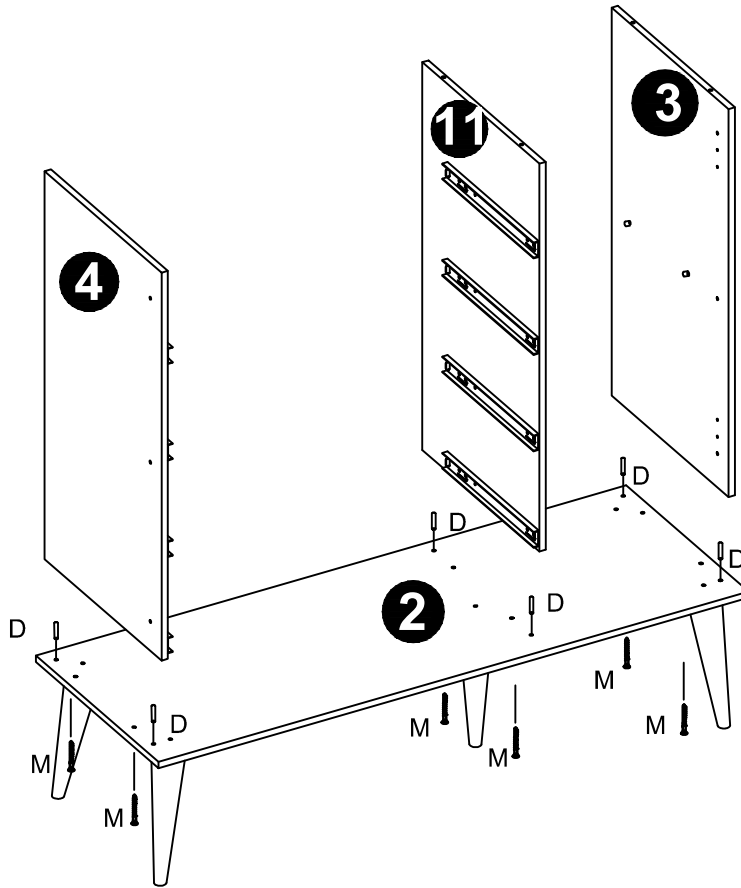

D 6 un.
Cavilha 6x30

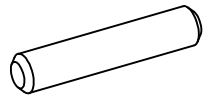

M 6 un.
Parafuso 4x40



PASSO 4 - MONTAGEM DO TAMPO E DAS MOLDURAS

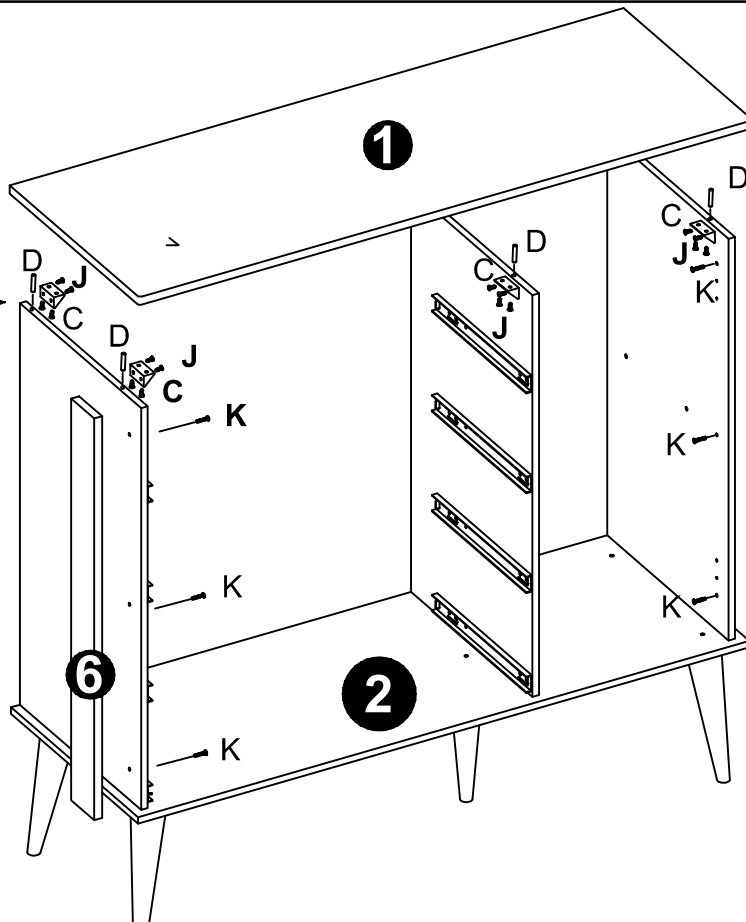
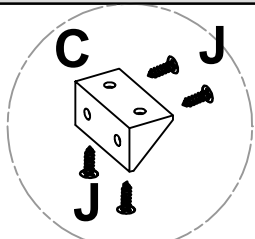

D 6 un.
Cavilha 6x30

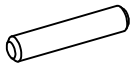

C 6 un.
Cantoneira c/ tampa

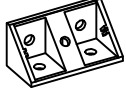

J 24 un.
Parafuso 3,5x12



K 6 un.
Parafuso 3,5x22

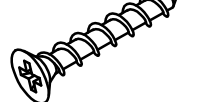

CÔMODA SAPATEIRA ÍSIS

PASSO 5- MONTAGEM DOS TRASEIROS

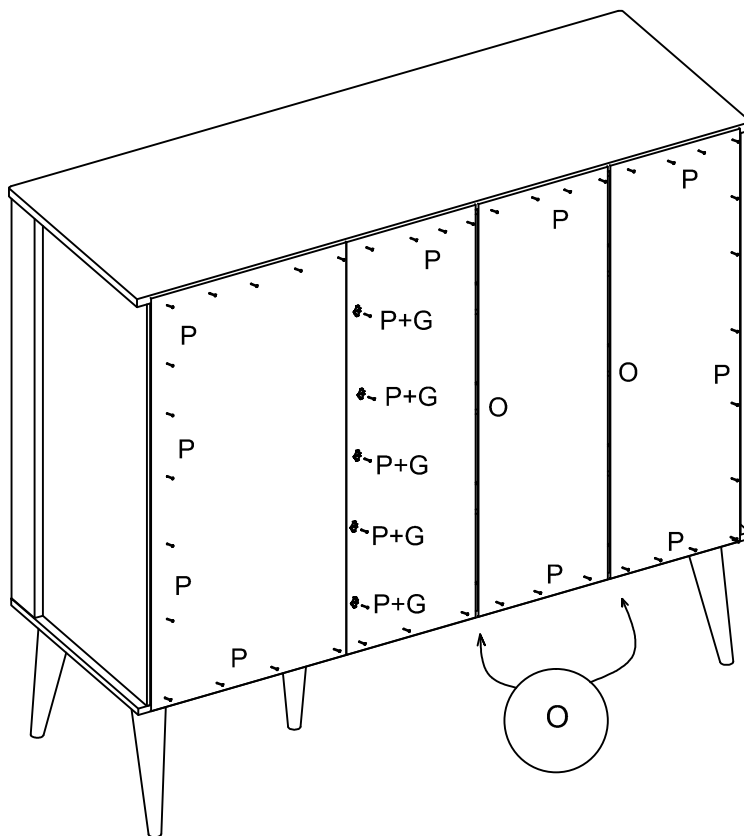

P 56 un.
Prego

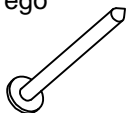

G 6 un.
Junção Traseiro



O 2 un.
Perfil H



PASSO 6-MONTAGEM DAS GAVETAS E PUXADORES

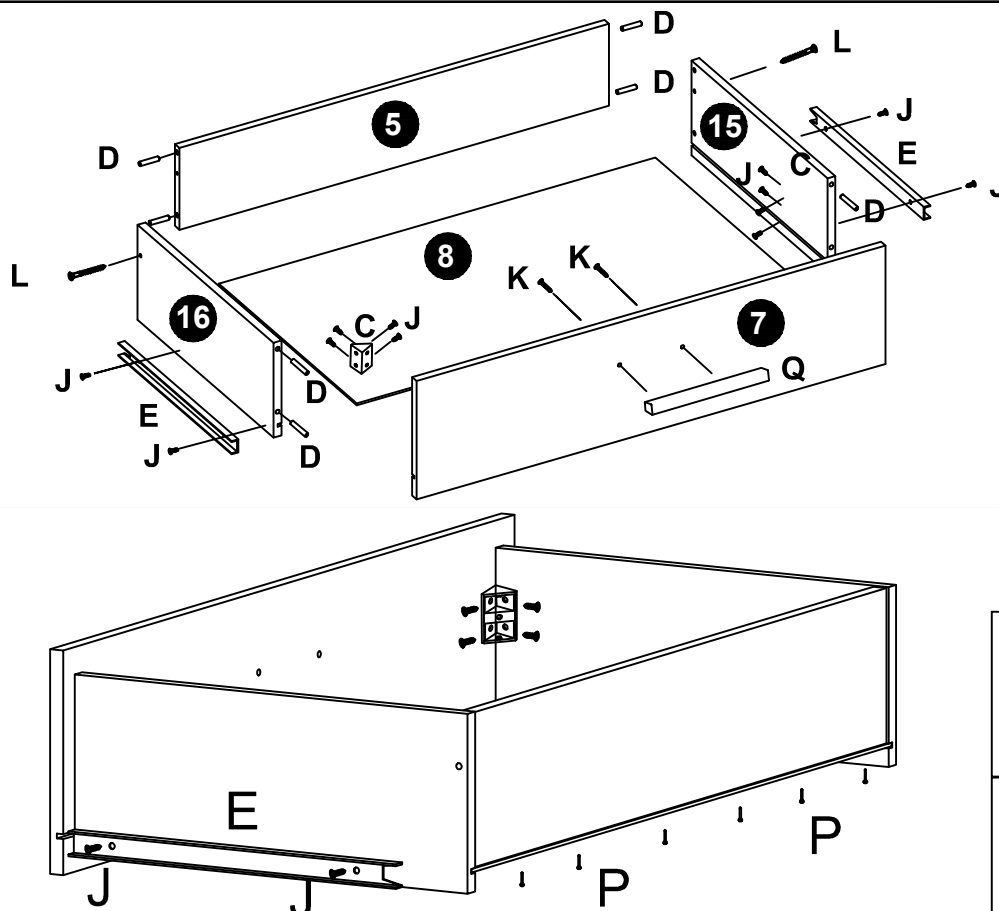

D 8 un.
Cavilha 6x30

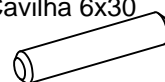

C 2 un.
Cantoneira
c/ Tampa



E 1 par
Corrediça



J 12 un.
Parafuso 3,5x12



Q 1 un.
Puxador

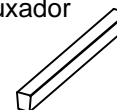

K 2 un.
Parafuso 3,5x22



P 6 un.
Prego



L 2 un.
Parafuso 3,5x40



CÔMODA SAPATEIRA ÍSIS

PASSO 7- MONTAGEM DO KIT ANTI TOMBAMENTO

Fixar o Móvel na parede

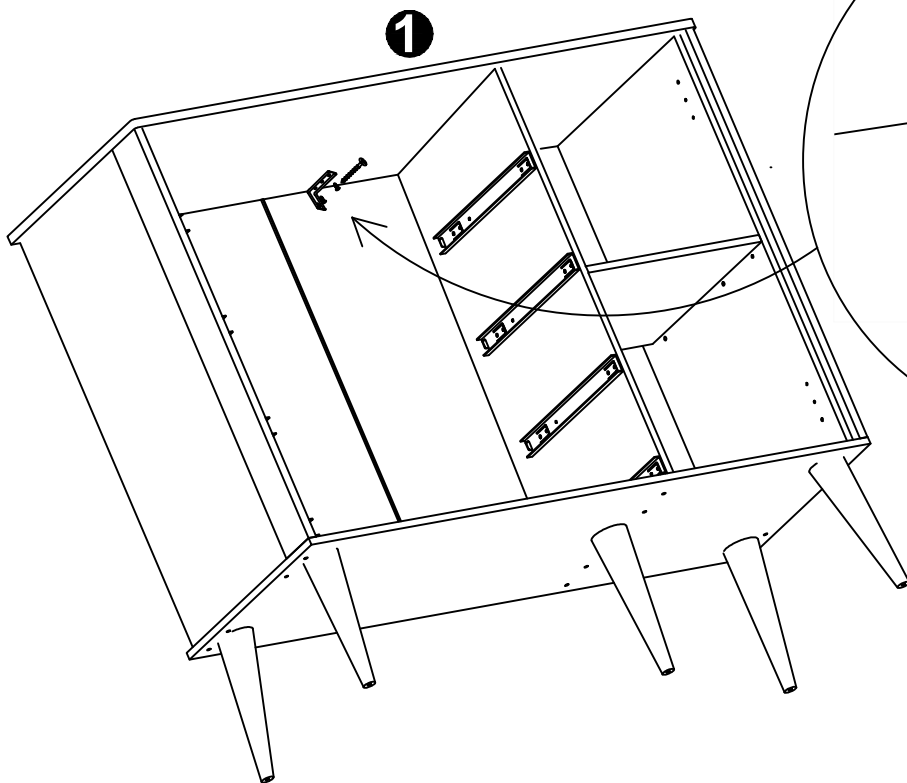

I 1 un.
Kit Anti Tombamento

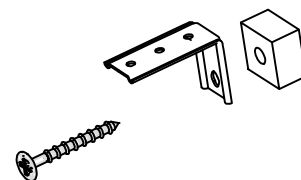

PASSO 8 : MONTAGEM DAS GAVETAS, PORTA E PRATELEIRA NA CÔMODA

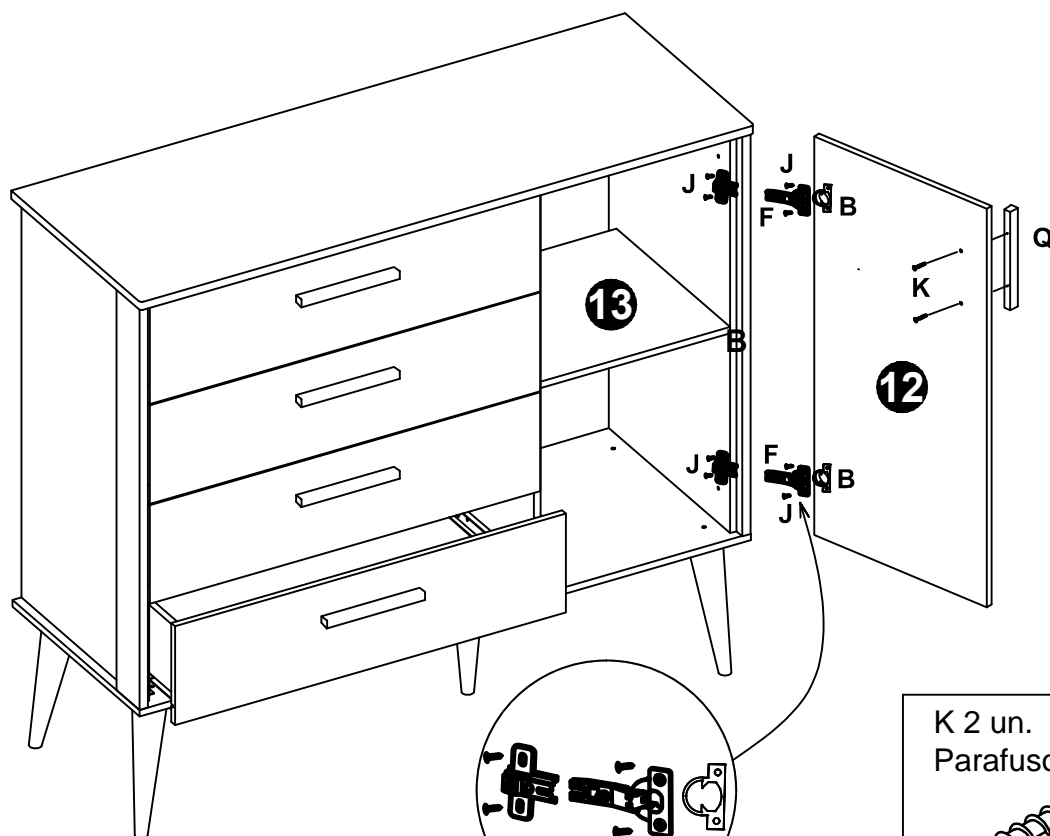

E 2 un.
Dobradiça

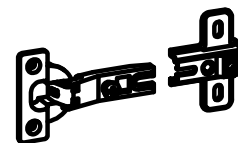

B 2 un.
Calço da Dobradiça

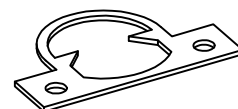

J 8 un.
Parafuso 3,5x12



K 2 un.
Parafuso 3,5x22

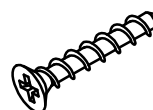

Q 1 un.
Puxador

